

# SECTION 1

# Hull fittings

KEY

■ for Dart 18 only

■ for Dart 15 only

■ Universal

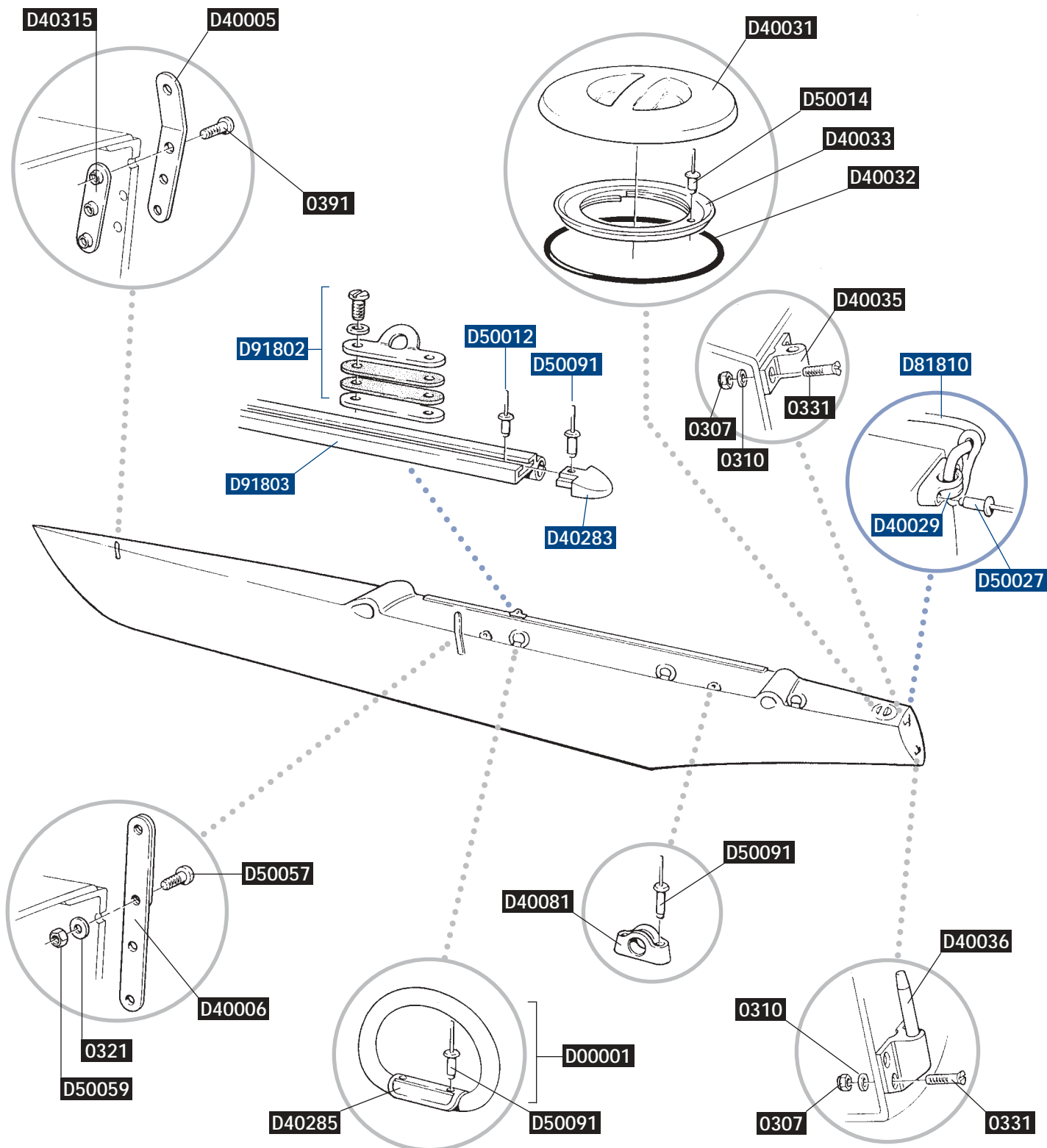

# SECTION 2

## Beam fittings

### KEY

- for Dart 18 only
- for Dart 15 only
- Universal

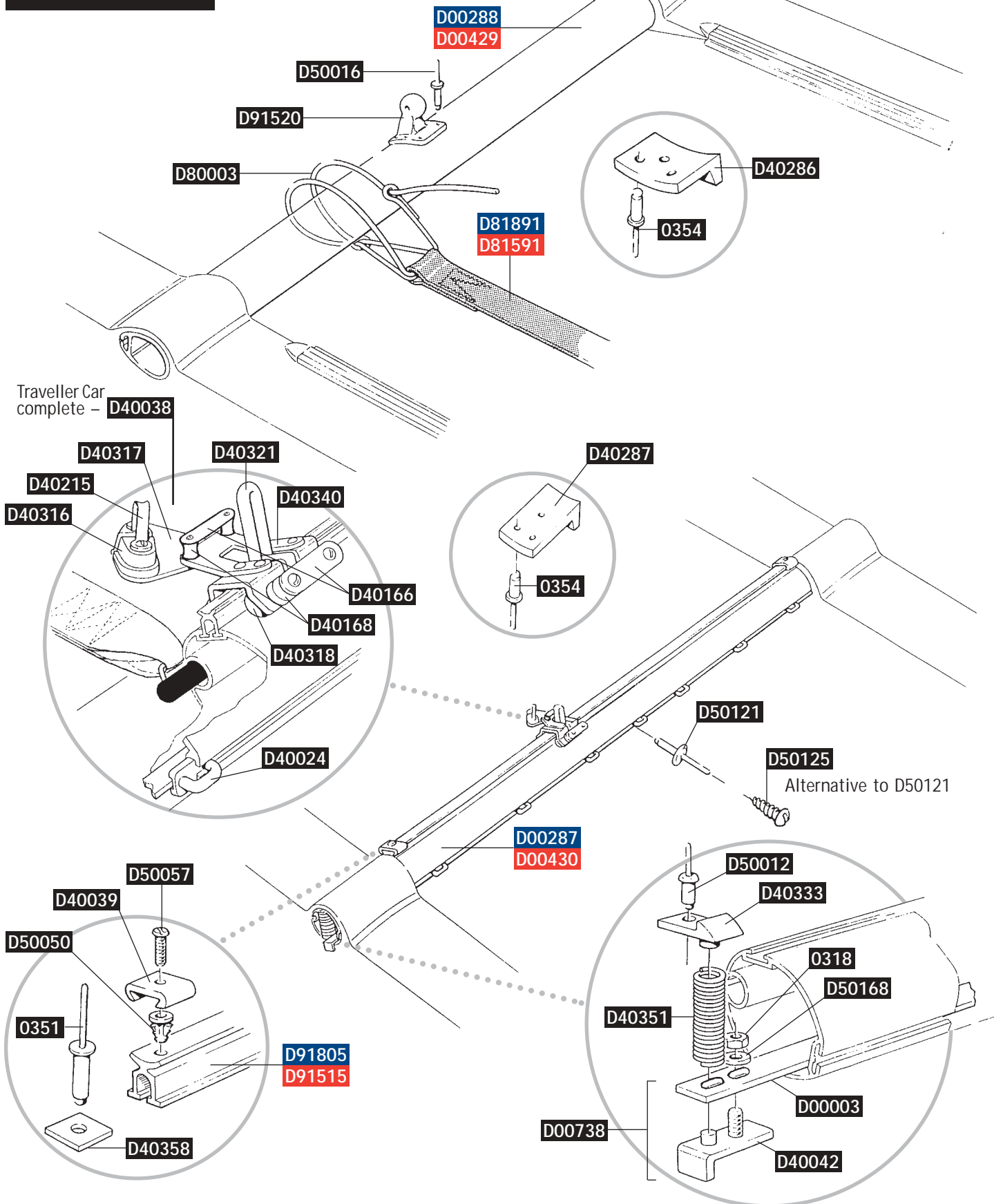

# SECTION 3

## Trampoline

KEY

■ for Dart 18 only

■ for Dart 15 only

■ Universal

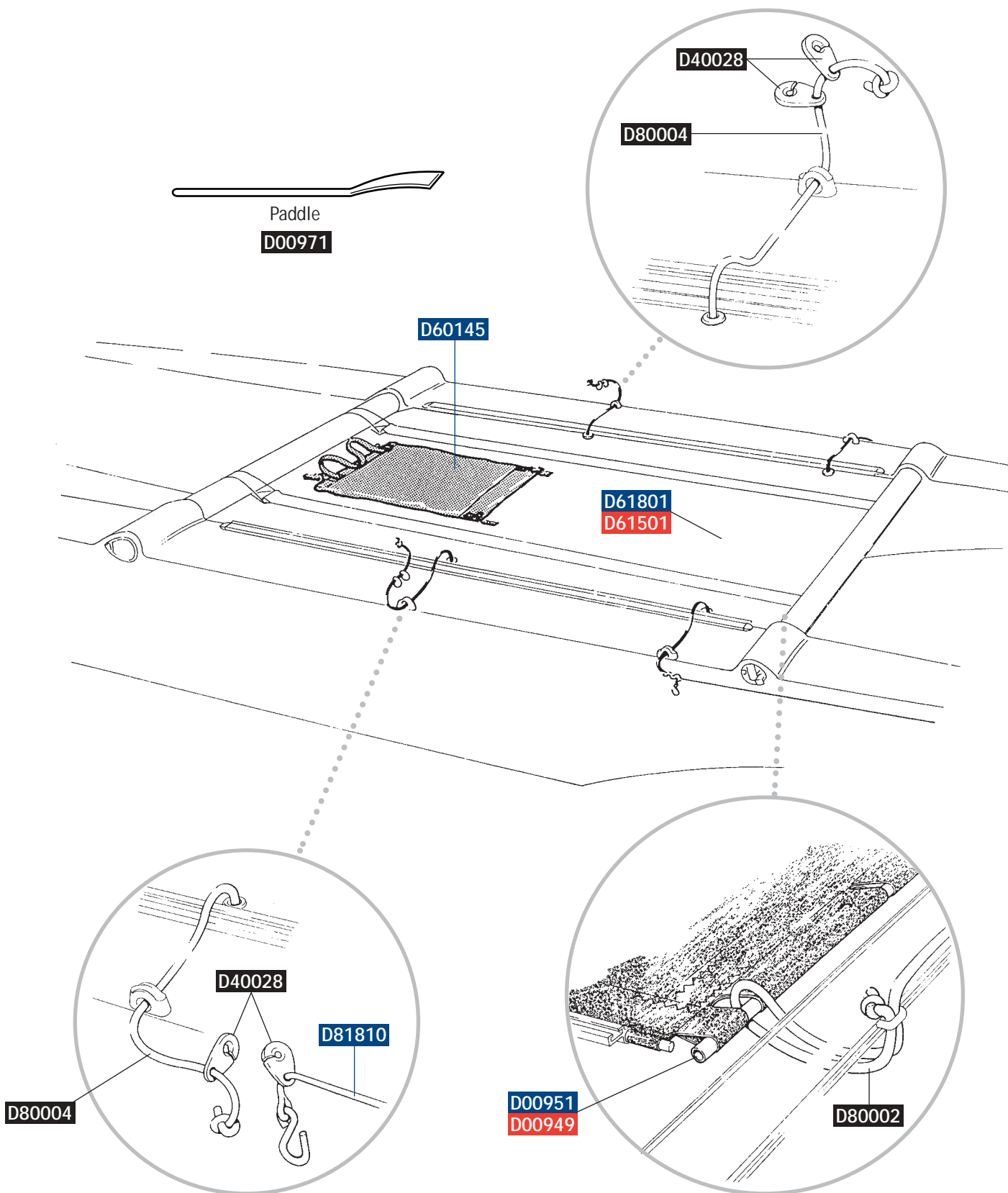

SECTION

# 4

## Tiller

KEY

- for Dart 18 only
- for Dart 15 only
- Universal

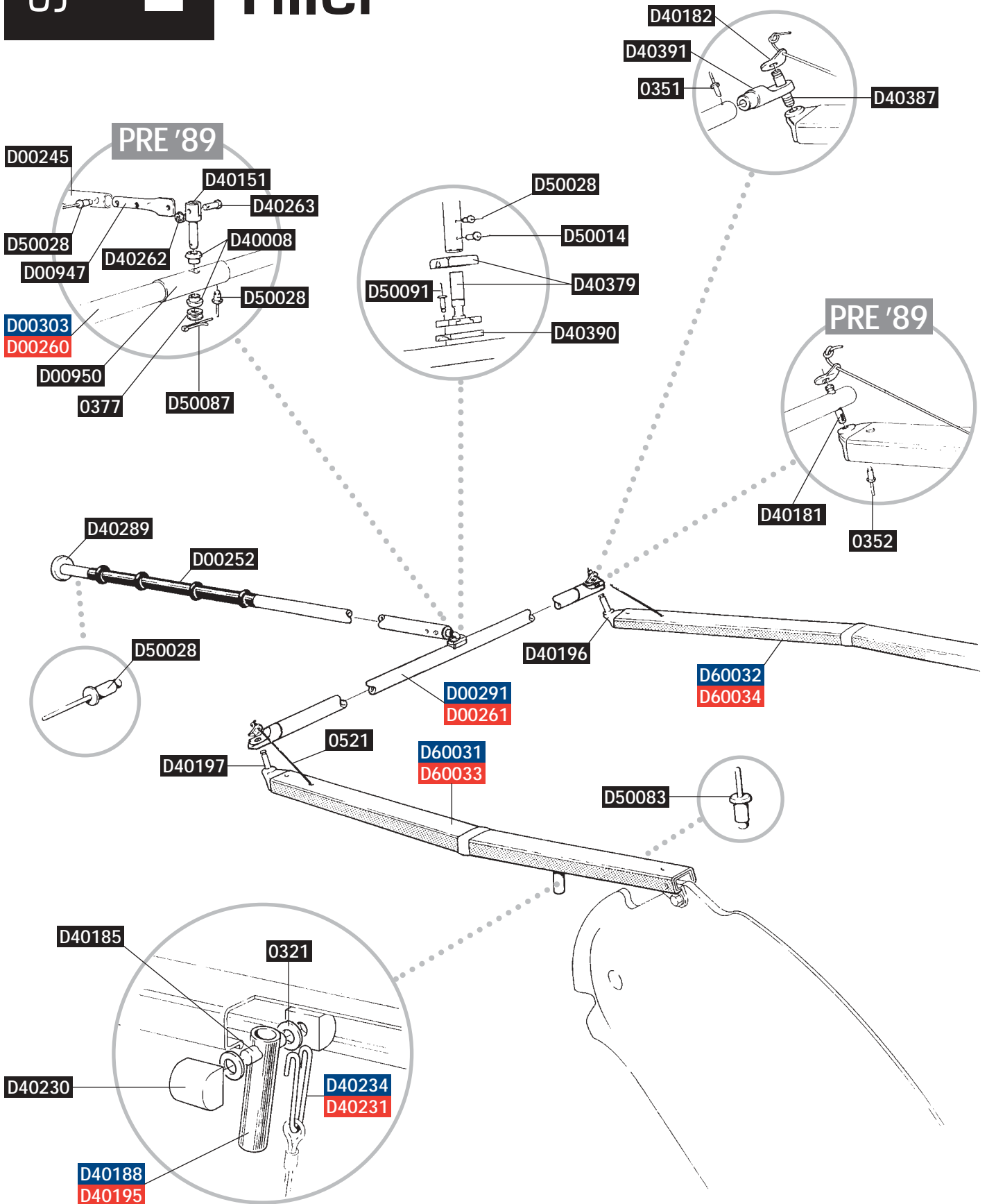

# SECTION 5

## Rudder stock

### KEY

- for Dart 18 only
- for Dart 15 only
- Universal

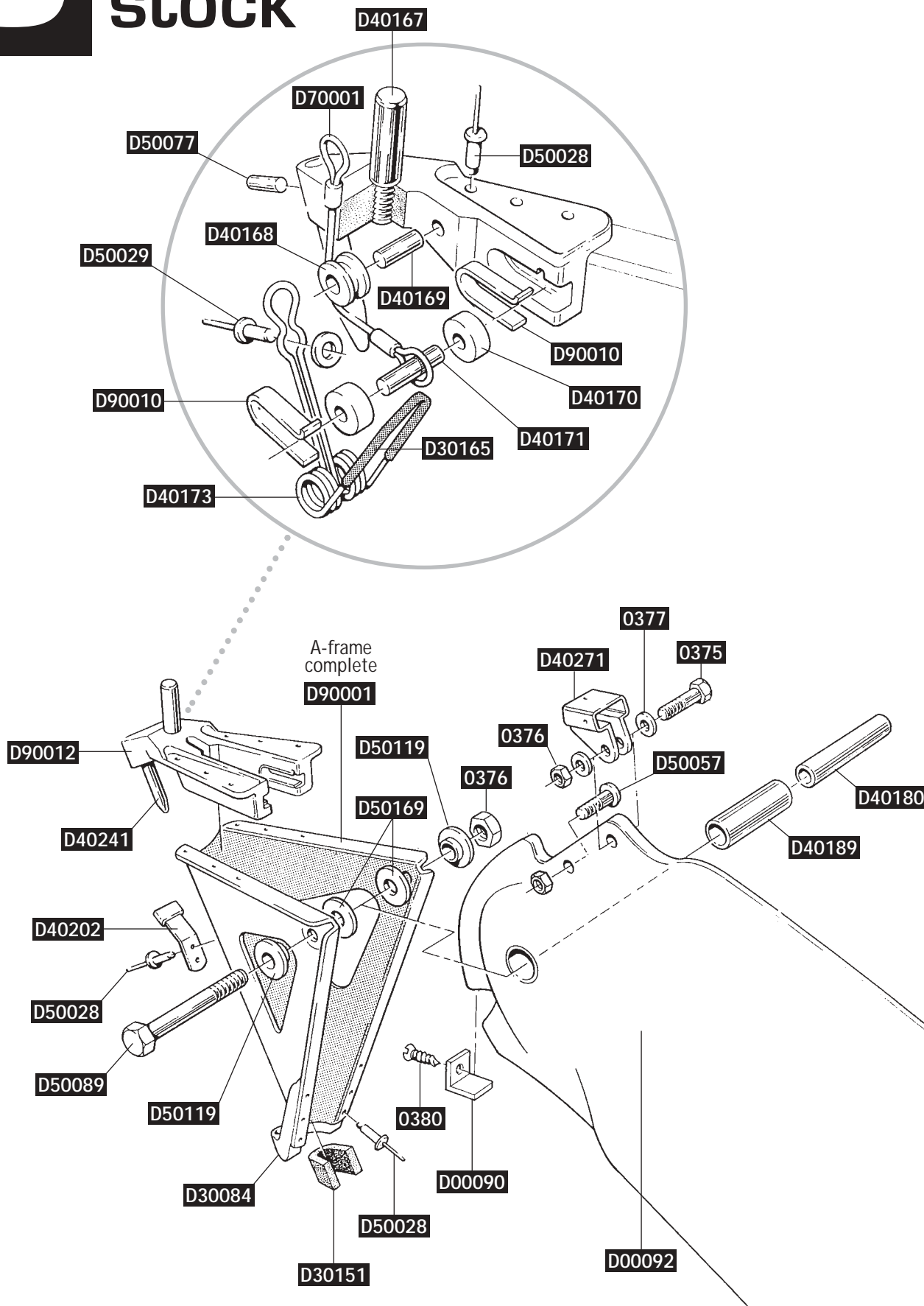

# Mast fittings and trapeze

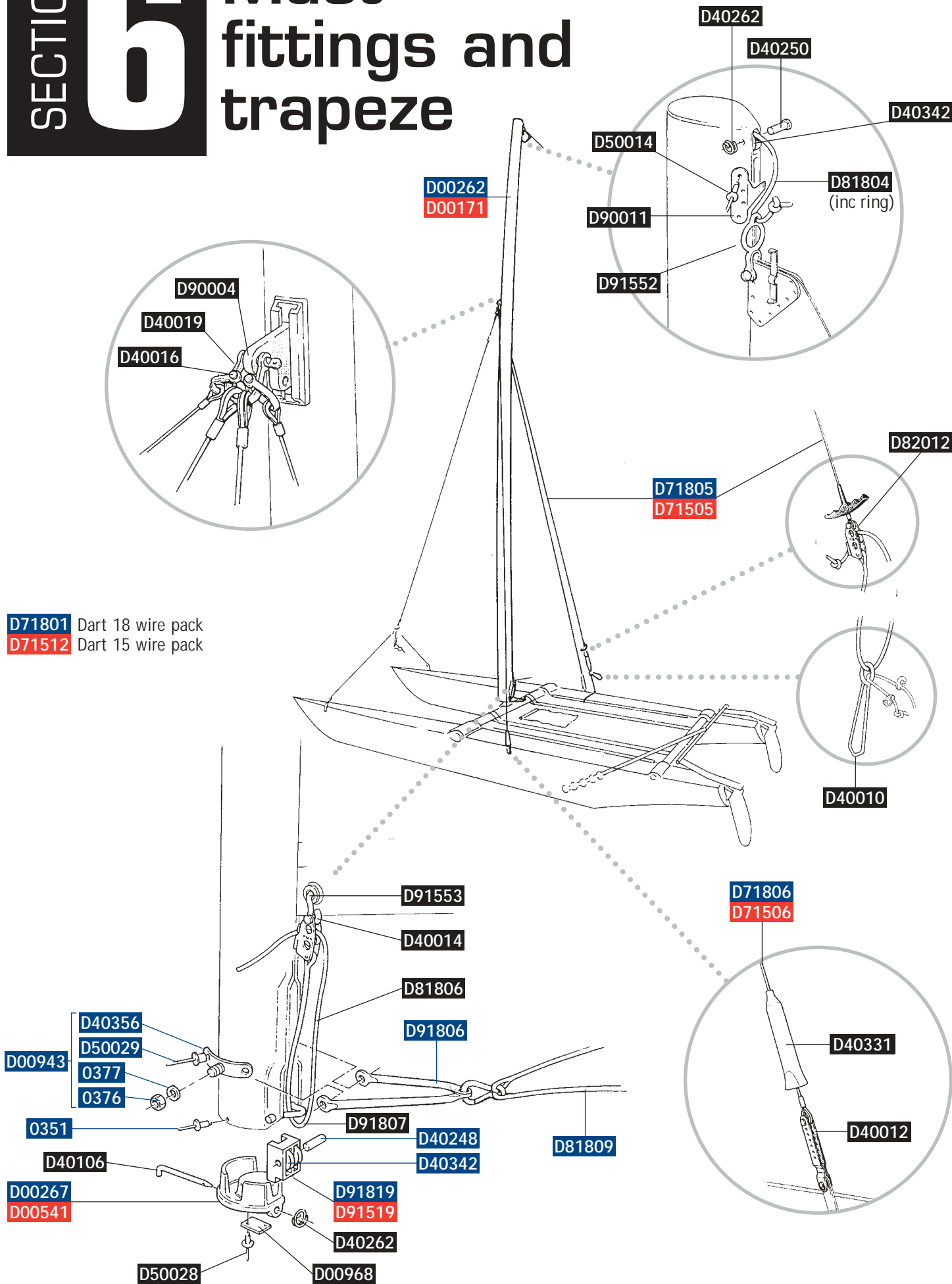

# SECTION 7

## Mainsail

### KEY

■ for Dart 18 only

■ for Dart 15 only

■ Universal

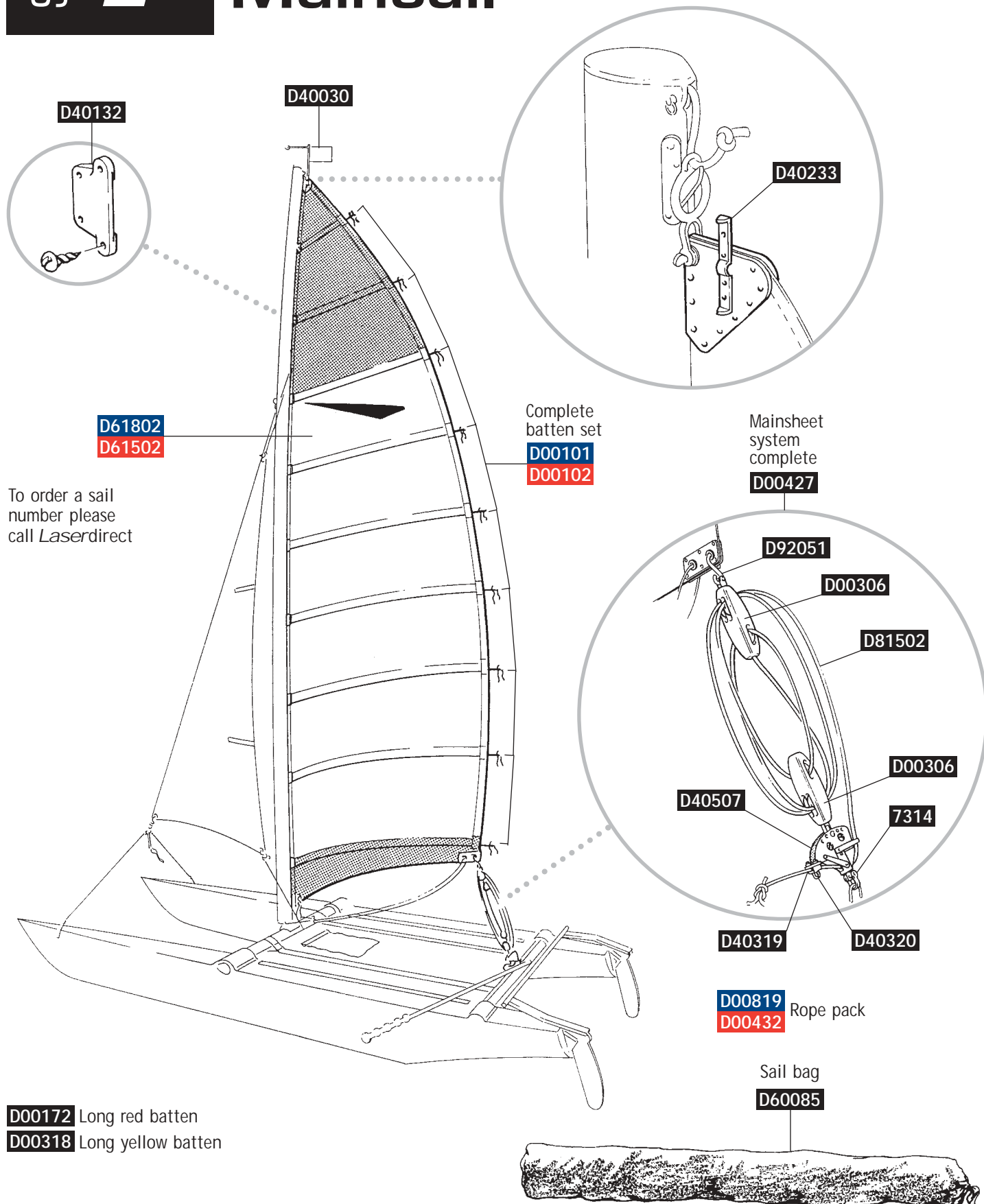

# SECTION 8

## Jib and jibsheet

### KEY

- for Dart 18 only
- for Dart 15 only
- Universal

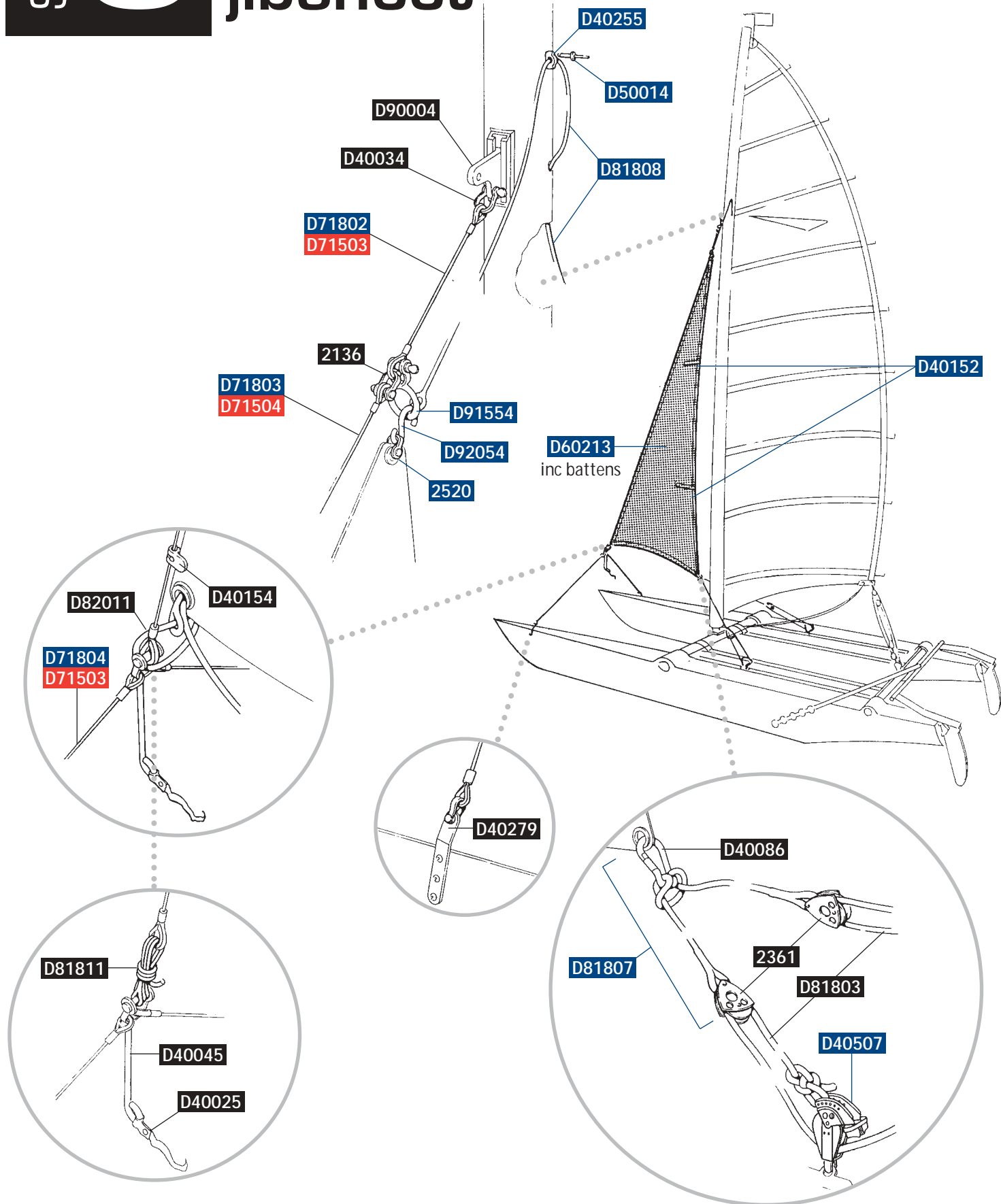



# Dart 15 specials

